

Kit Contents		
Description	Part No	Pcs
Steering damper str1 63	02262-10	1
Washer 8.4/24/2	00426-03	1
Sleeve	02238-18	1
Spacer PA	02259-01	1
Screw M8x60	01046-53	1
Bracket assy 02205-11	02230-09	1
Sleeve	02238-10	1
Sleeve	02238-16	1
Screw M8x35	05404-05	1
Owner's Manual	07261-02	1
Sticker "ÖHLINS"	10207-01	1

👁 Note!

Please note that there can be small differences between your product and the images in these instructions.

👁 Note!

Please note that during storage and transport, especially at high ambient temperature, some of the oil and grease used for assembly may leak and stain the packaging. This will not cause damage to the product, wipe off the excessive oil or grease with a cloth.

👁 Note!

Before you install this product, check the kit contents. If anything is missing, please contact an Öhlins dealer.

⚠ Warning!

Before you install this product, read the Öhlins Owner's manual. This product is an important part of the vehicle and the vehicle stability.

Steering damper for BMW S1000RR

SD 064

Mounting Instructions



MOUNTING INSTRUCTIONS

⚠ Warning!

We strongly recommend to let an Öhlins dealer install this product.

⚠ Warning!

If you work with a lifted vehicle, make sure that it is safely supported to prevent it from tipping over.

👁 Note!

When you work with this product, see the vehicle service manual for vehicle specific procedures and important data.

👁 Note!

Before you install this product clean the vehicle.

1

Remove the plastic cover below original steering damper.

2

Remove the original steering damper.

3

Mount the Öhlins steering damper to Bracket assembly (02230-09). Mount according to figure.

4

Mount the Öhlins steering damper to the frame.

Use Sleeve 02238-18
 Spacer PA 02259-01
 Screw M8x60 01046-53
 Sleeve 02238-10

5

Fasten the end eye to the triple clamp, from below.

Use Screw M8x35 05404-05
 Washer 8.4/24/2 00426-03
 Sleeve 02238-16

6

Loosen the screws to Bracket assembly (02230-09) in step 4. Adjust the steering damper by letting it slide in its bracket assembly so that the steering damper uses similar stroke both ways.

👁 Note!

Make sure that the steering has clearance for turning both to the left and to the right end positions, and that the damper is not used as a stop.

7

Mount the plastic cover back.

👋 Caution!

Make sure that you tighten all screws to the correct torque and that nothing fouls or restricts movement of the shock absorber/front fork/steering damper when the suspension is fully compressed or extended.

MOUNTING INSTRUCTIONS

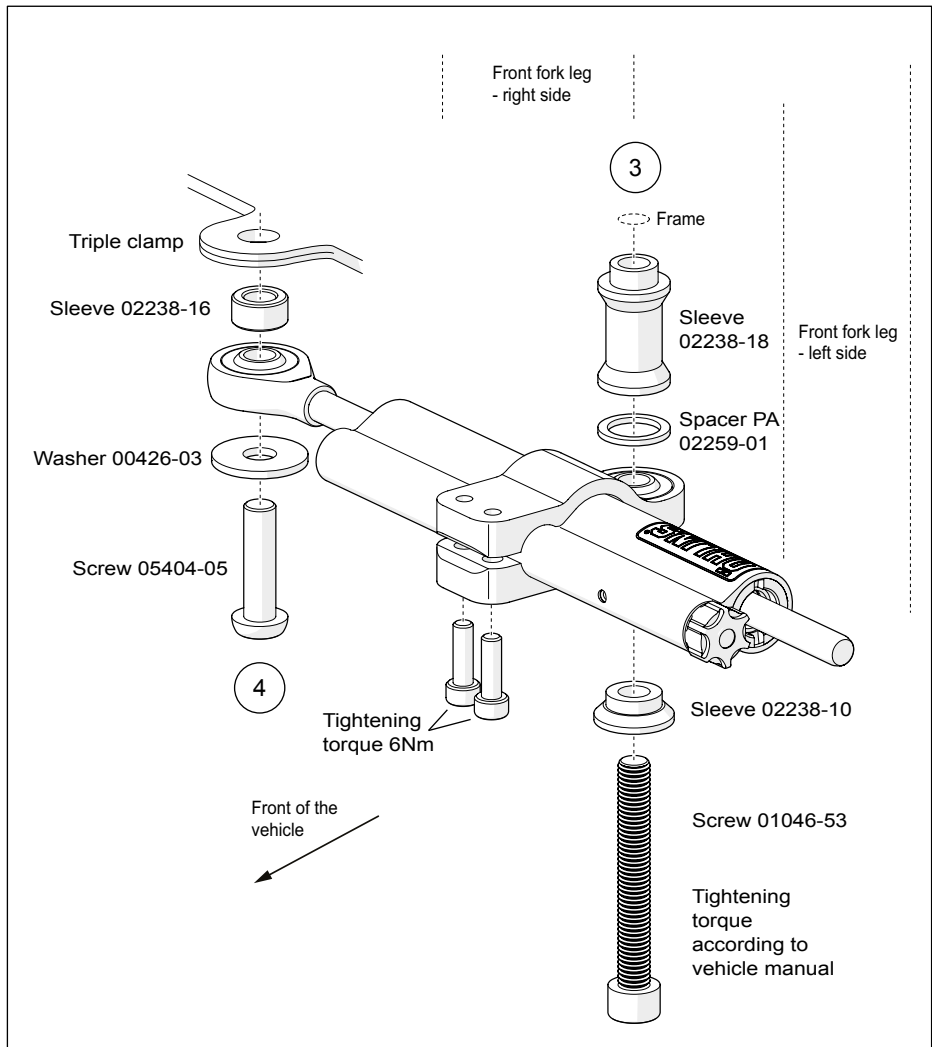

ADJUSTMENTS

⚠ Warning!

Before you ride/drive, always make sure that the setup is according to the recommended setup data. Read about adjustments and setting up in the Öhlins Owner's Manual before you make any adjustments. Contact an Öhlins dealer if you have any questions about setting up.

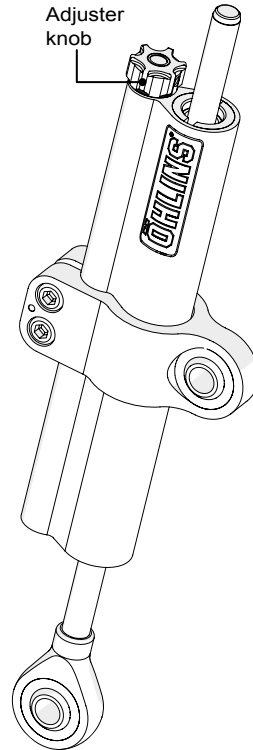

SETUP DATA

Recommended set-up	10	clicks
--------------------	----	--------

Öhlins products are subject to continuous improvement and development, therefore, although these instructions include the most up-to-date information available at the time of printing, minor updates may occur.

To find the latest information contact an Öhlins distributor. Please contact Öhlins if you have any questions regarding the contents in this document.

Part no. MI_SD064_0
Issued 2019-04-11

© Öhlins Racing AB. All rights reserved. Any reprinting or unauthorized use without the written permission of Öhlins Racing AB is prohibited.

Öhlins Racing AB
Box 722
S-194 27 Upplands Väsby, Sweden
Phone +46 8 590 025 00
fax +46 8 590 025 80



www.ohlins.com